

# Woodwiz®

## SPLITTER

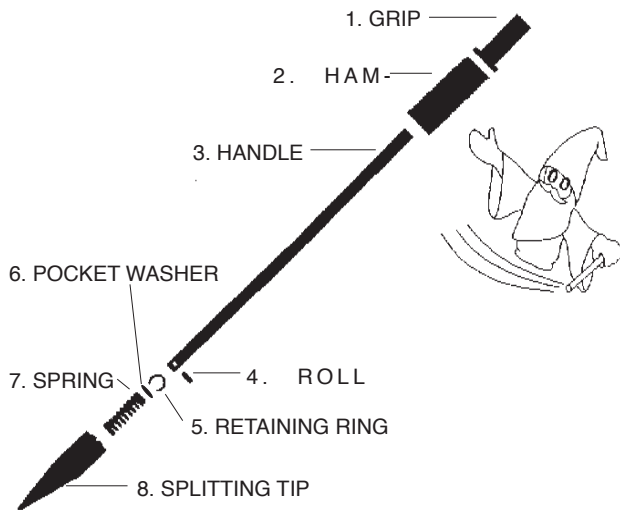

1. GRIP.....	\$5.00
2. HAMMER.....	\$20.00
3. HANDLE*.....	\$25.00
4. ROLL PIN.....	\$2.00
5. RETAINING RING.....	\$3.00
6. POCKET WASHER.....	\$4.00
7. SPRING.....	\$5.00
8. SPLITTING TIP.....	\$44.00

\*Handle includes pre-assembled Roll Pin, Spring and Pocket Washer plus shipping.

Parts can be ordered online at [www.woodwiz.com](http://www.woodwiz.com)

Easy Motion Inc. feels that the Woodwiz® Splitter is a valuable product for people who cannot split using other means. Great care has been taken to make the tool user-friendly and durable. Easy Motion Inc. shall not be liable for incidental, consequential or special damages arising out of, or in connection with product use or performance except as may otherwise be accorded by law.

PLEASE MAKE CHECKS PAYABLE TO:  
**EASY MOTION INC.**

Dept. I

P.O. Box 1285 • Vestal, NY 13850  
website: [www.woodwiz.com](http://www.woodwiz.com)  
e-mail: [woodwiz@woodwiz.com](mailto:woodwiz@woodwiz.com)

## What People Are Saying...

*"Your wood splitter is terrific! (I) am giving them as Christmas presents to other members of the family. Great invention!"*

**Joan & Richard Jensen, Canton, MA**

*"What I had expected to be a monumental task for me to split our wood, proved to be much easier and faster than I thought, with the help of your wood splitter."*

**Gloria Thompson, Apalachin, NY**

*"I particularly like to use this splitter on the wood I have drying in the basement of my house. I am impressed with the engineering/mechanical concepts of this splitter."*

**Donald Beattie, Former President, Broome Community College, Binghamton, NY**

*"I am a paraplegic, and burn wood for the major portion of my heat. It is essential that I am able to split my own wood. This splitter is the safest way for me to do it. Now I even enjoy making kindling. This tool is invaluable to disabled people."*

**Donald Gotschall, Choconut, PA**

*"This wood splitter has been great for my husband who had a stroke seven years ago, and had not been able to split wood until we discovered your wood splitter."*

**Mrs. Jean Schrade, Duanesburg, NY**

*"Congratulations on a well-designed and made wood splitting tool. I am musing why I didn't have the good sense to design a tool like yours."*

**Paul Kingsley, M.D., Ross, CA**

*"Although I was skeptical of your claims, I ordered the splitter because it looked like such a great innovation. I just received my splitter yesterday and I must say, I am astounded at how well it works. However, I believe you have undersold yourself—many of my large pieces did NOT have natural cracks. It did not matter—the splitter made its own crack and went right through even the biggest pieces of firewood. I will be spreading the news about this incredible tool to my family and friends. I am 110% satisfied—great job!"*

**Mark McCall, Weston, CT**

# Woodwiz®

## SPLITTER

by: **EASY MOTION INC.**

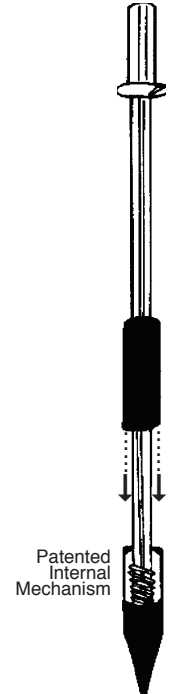

## A Wood Splitter for All Reasons

- The Safer Way to Split Wood
- No Swinging • No Missing
- No Smashed Fingers or Feet
- No Mushroomed Wedges
- No Flying Slivers of Steel
- Split Wood Indoors • No Bounce Out!
- Make Kindling Safely • A Real Back Saver

**MADE IN THE USA**

## BEFORE YOU START!

**Always wear eye, ear and foot protection and work gloves when splitting wood!**

1. With **one** hand, **hold the grip** and place the splitting tip on the end of an upright log.

2. Keeping a firm hold on the grip, **toss the hammer** in a downward motion.

**CAUTION: Be sure to release the weight before it contacts the splitting tip!**

3. Repeat step #2 until the log is split.

Splitting wood sometimes requires a little style and awareness! Here are some suggestions that we and satisfied owners recommend.

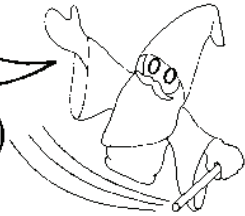

- Ease up on the last stroke to increase tool life.
- Placing a board under your log will keep the tip sharp. (Tip may be sharpened with a metal file.)
- Start the tool in a straight line that aims through the length of the log, keeping the splitter going in the direction of the grain.
- Place tip in **seasoning cracks**. This works best for all wood, especially knots.
- Some logs are too big to split in half (as is true with axes and mauls.) Start at the outside of the log, splitting off wood, and work around until the log is fireplace size.
- If, in the **unlikely** event, the tool becomes stuck, **do not** try to force the tool out. The handle may bend. If this **happens, bend it back the same way!** Drive the tool all the way through. Or in the extreme case where the tool resists movement in any direction, it may be necessary to use a wedge and sledge to free it.
- For **safety** reasons always **carry the Woodwiz® Splitter upright by the handle**. This will prevent the hammer from pinching skin or fingers.

The **patented Woodwiz® Splitter** is made in USA and guaranteed to be free from defects in materials or workmanship for a period of one year, and we will repair or replace a defective splitter upon receipt of tool and proof of purchase. Your retailer may have a different warranty policy.

**Note:** EasyMotion Inc. cannot assume responsibility for a handle that has been bent. See next page for handle replacement.

## HANDLE REPLACEMENT

**Please wear eye and foot protection!**

(Do it yourself or take these step by step instructions along with your splitter to your local garage or hardware store.)

**First: Try straightening the handle by bending!**

### I. DISASSEMBLY:

(you will need a screwdriver)

1. Hold upright, **tap the hand grip off** using the sliding weight as in figure 1. If handle has been bent severely use a hammer and alternately tap on either side under the grip to remove it.

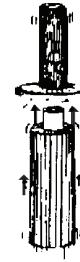

Figure 1

2. **Remove the hammer.** If the handle has been bent such that the weight is jammed, use a hacksaw to cut the handle off just above the weight and then remove it.

3. **Remove the retaining ring.**

a. Using a screwdriver, **push one end of the retaining ring down** into the well and **continue around** until the ring is about 1/8" to 1/4" below its original, seated position. (See Figure 2)



Figure 2

b. Using the screwdriver, **grab under an end of the ring and gently coax** that end **above the groove**.

c. **Work around** the handle until the ring has been freed. (See Figure 3)

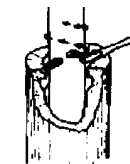

Figure 3

Please note that it is possible to deform the retaining ring so we suggest using **patience during removal**.

4. Hold the splitting tip with one hand and pull the handle free with the other hand. If you have already purchased a Replacement Handle from us, please proceed to III. REASSEMBLY on the next page.

## II. HANDLE CONSTRUCTION:

(You will need a 3/16" drift punch, hammer, hacksaw, and 1/4" drill)

1. **Push roll pin out** with a drift punch (or cut off nail) and hammer (see Figure 4) and remove spring and ring. (See parts list on page 4 should you wish to replace any part.)

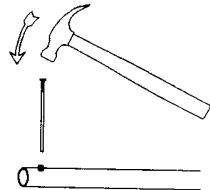

Figure 4

2. **Cut a new piece** of 1/2" I.D. seam welded pipe (gas pipe commonly available at hardware stores) to 51."

Note: Increasing the length of the pipe will raise the velocity of the hammer, therefore increasing the impact. Easy Motion Inc. cannot guarantee the tool if this has been done.

3. **Drill 1/4" hole** through one end **centered 3/8"** from that end.

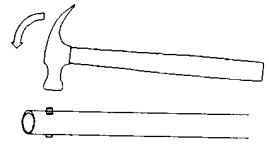

Figure 5

4. **Drive roll pin** through so that ends project equally as in Figure 5.

5. Slip spring, pocket washer, then retaining ring down pipe.

### III. REASSEMBLY:

(you will need a screwdriver)

1. **Replace handle** with spring then pocket washer into splitting tip and **push retaining ring** with the screwdriver **one end first** (see Figure 6) **working around** slowly several times until ring is **seated or past the groove** (see Figure 2.)

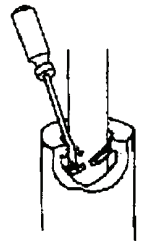

Figure 6

2. Hold the tip with one hand and handle with the other hand and **give a strong tug trying to pull them apart** (see Figure 7). It will **click** into place. Make sure it has seated evenly by looking down into it. If you suspect the ring is still above the groove, push it again with the screwdriver.

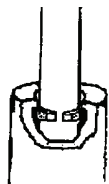

Figure 7

3. **Replace hammer and grip** back on handle (a little hair spray will help).